

Model FTCM

IT	GB	FR	E	DE
Protezione mobile interbloccata	Moveable interlocked guard	Protecteur mobile asservi	Protección móvil con microinterruptor	Bewegliche, verriegelte Schutzeinrichtung
1.0 Introduzione 2.0 Dati tecnici 3.0 Installazione 4.0 Funzionamento/uso 5.0 Certificazione 6.0 Identificazione 6.1 Controllo qualità 7.0 Manutenzione 8.0 Cond.di stoccaggio 8.1 Smaltimento 9.0 Disegno+Esploso 10.0Esempio di montaggio	1.0 Introduction 2.0 Technical Data 3.0 Installation 4.0 Operation and use 5.0 Certification 6.0 Identification 6.1 Quality control 7.0 Maintenance 8.0 Storage conditions 8.1 Disposal 9.0 Design anddetailedview 10.0Exemple of assembly	1.0 Présentation 2.0 Données techniques 3.0 Installation 4.0 Fonctionnement et emploi 5.0 Certification 6.0 Identification 6.1 Le contrôle de qualité 7.0 Entretien 8.0 Condition de stockage 8.1 Bélimination 9.0 Plan et explosé 10.0Exemple de montage	1.0 Introducción 2.0 Datos técnicos 3.0 Instalación 4.0 Funcionamiento utilización 5.0 Certificación 6.0 Identificación 6.1 Control de calidad 7.0 Mantenimiento 8.0 Condiciones de almacenamiento 8.1 Disposición 9.0 Plano de despiece 10.0Ejemplo de montaje	1.0 Einführung 2.0 Technische Daten 3.0 Installation 4.0 Betrieb und Nutzung 5.0 Zertifizierung 6.0 Identifizierung 6.1 Qualitätskontrolle 7.0 Wartung 8.0 Lagerbedingungen 8.1 Entsorgung 9.0 Zeichnung und explodierte Bild 10.0Montage Beispiel

1.0 Introduzione	1.0 Introduction	1.0 Presentation	1.0 Introduccion	1.0 1.0 Einführung
<p>La protezione mobile è destinata ad essere integrata in una macchina utensile, per poter garantire un interblocco sul funzionamento del mandrino.</p> <p>Per tale motivo è presente un dispositivo di interblocco di tipo elettromeccanico, ad azione positiva, la cui affidabilità viene identificata nella tabella, DatiTecnici- 2.0</p>	<p>The moveable guard is designed for integration into a machine tool, in order to guarantee interlocking of the spindle operation.</p> <p>There is a positive-action electromechanical interlocking device, the specifications of which are detailed in the technical data table-2.0</p>	<p>La protection mobile est destinée à être intégrée sur une machine-outil pour pouvoir garantir un inter-blocage sur le fonctionnement du mandrin.</p> <p>Pour cette raison un dispositif d'interblocage de type électromécanique, à action positive, est présent, dont la fiabilité est identifiée dans le tableau Données Techniques.2.0</p>	<p>La protección móvil está destinada a ser integrada en una máquina herramienta a fin de garantizar la detención del funcionamiento de la broca en caso de apertura de la protección.</p> <p>Por este motivo dispone de un microinterruptor de seguridad, de acción mecánica positiva, cuya fiabilidad se garantiza en la tabla de Datos Tecnicos-2.0</p>	<p>Diese bewegliche Schutzvorrichtung ist dazu bestimmt, auf einer Werkzeugmaschine integriert zu werden, um die Verriegelung des Spindelbetriebs zu gewährleisten.</p> <p>Aus diesem Grund ist eine elektromechanische mit positiver Wirkung Sicherheitsverriegelung vorhanden, deren Betriebssicherheit in der Tabelle mit den Technischen Angaben-2.0 festgestellt werden kann.</p>
Dispositivo di interblocco	Interlocking device	Dispositif d'interblocage	Microinterruptor	Interlock-Vorrichtung



Code MIC 004

2.0 Dati tecnici	2.0 Technical data	2.0 Données techniques	2.0 Datos técnicos	2.0 Technische Daten
Spessore Polycarbonato: 4mm Peso: 10/20Kg Grado di protezione dispositivo di interblocco: IP67 B10d (numero di cicli): 20,000,000 Apertura forzata: SI	Polycarbonate thickness: 4mm Weight : 10/20kg Interlocking device degree of protection: IP67 B10d (number of cycles): 20,000,000 Forced opening: Yes	Épaisseur polycarbonate: 4mm Poids: 10/20kg Degré de protection du dispositif d'interblocage : IP67 B10d (nombre de cycles): 20.000.000 Ouverture forcée: Oui	Groso polycarbonato: 4mm Peso: 10/20kg Grado de protección microinterruptor: IP67 B10d (número de ciclos): 20.000.000 Acción mecánica positiva: SI	Stärke Polycarbonat: 4mm Gewicht : 10/20g Schutzart der Interlock-Vorrichtung: IP67 B10d (Anzahl der Zyklen): 20.000.000 Zwangsöffnung: JA

3.0 Installazione	3.0 Installation	3.0 Installation	3.0 Instalación	3.0 Installation
Il sollevamento del riparo può avvenire a mano. La protezione deve essere fissata mediante viti M6 (non fornite). Una volta installata e fissata la protezione occorre cablare i contatti del dispositivo di interblocco al circuito di sicurezza al fine di garantire l'arresto del mandrino (a cura del installatore).	The guard can be lifted by hand. The guard must be secured with M6 screws (not provided). Once the guard is installed and secured, the contacts of the interlocking device need to be wired into a safety circuit by the installer in order to guarantee chuck stopping. This is a mandatory requirement-see the Machinery Directive.	Le levage du protecteur peut être exécuté manuellement. La protection doit être fixée à l'aide de vis M6 (non fournies) . Après avoir installé et fixé la protection, il faut câbler les contacts du dispositif d'interblocage au circuit de sécurité afin de garantir l'arrêt du mandrin autocentrant (à exécuter par le client final).	La manipulación de la protección puede realizarse a mano . La protección debe fijarse mediante tornillos M6 (no suministrados) . Una vez instalada y fijada la protección es necesario cablear las conexiones del microinterruptor al circuito de seguridad a fin de garantizar la parada segura del taladro (conexión a cargo del cliente).	Das Hochheben der Schutzeinrichtung kann per Hand erfolgen. Sie ist mit M6 Schrauben (nicht im Lieferumfang) . Nachdem die Schutzeinrichtung montiert und befestigt worden ist, müssen die Kontakte der Interlock-Vorrichtung an das Sicherheitskreis angeschlossen werden, um die Sperre des Spindels zu garantieren (durch ein Monteur durchzuführen).

N°4 Fori di fissaggio	Four off fixing holes	N°4 Trous de montage	N°4 Orificios de montaje	N°4 Befestigungslöcher
-----------------------	-----------------------	----------------------	--------------------------	------------------------

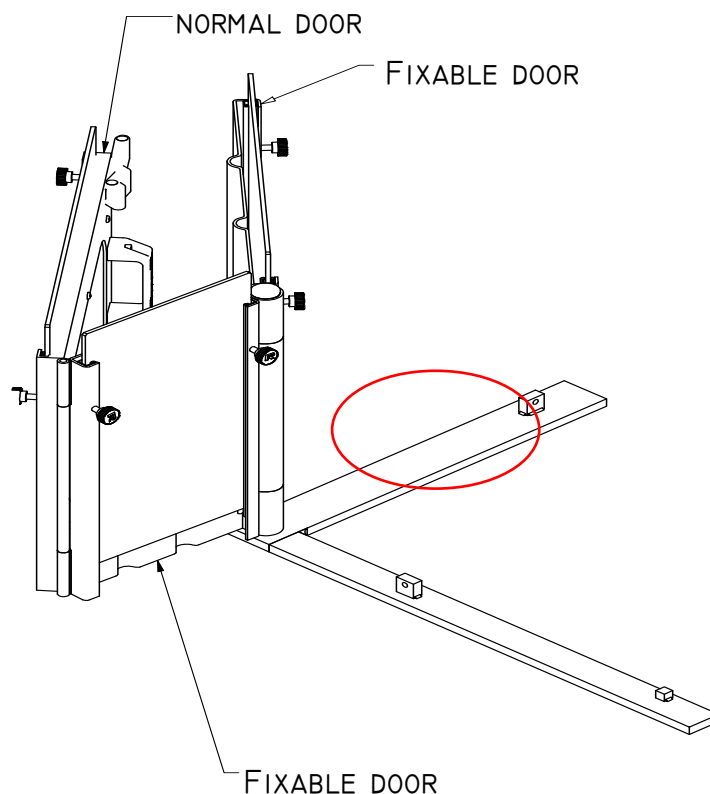

3.0

Schema dispositivo di interblocco	Contact plan of interlock device	Contactez dispositif de verrouillage du régime	Ver esquema del microinterruptor de seguridad	Kontaktplan der Interlock-Vorrichtung
-----------------------------------	----------------------------------	--	---	---------------------------------------



Code MIC 004

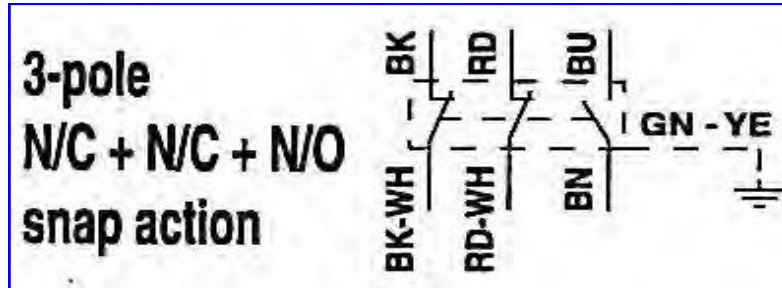





Contatto normalmente chiuso	Normally closed contact	Contact normalement fermé	Contacto normalmente cerrado	Öffner	<i>N/C</i>
Contatto normalmente aperto	Normally opened contact	Contact normalement ouvert	Contacto normalmente abierto	Schließer	<i>N/O</i>
Cavo Nero-Bianco Cavo Nero	Black-white cable Black cable	Fil noir et blanc Fil noir	Cable Negro-Blanco cable Negro	Kabel Schwarz-Weiß (1. Öffner) Kabel Schwarz	BK-WH BK
Cavo Rosso-Bianco Cavo Rosso	Red-white cable Red cable	Fil rouge et blanc Fil rouge	Cable rojo - blanco cable rojo	Kabel Rot-Weiß (2. Öffner) Kabel Rot	RD-WH RD
Cavo Marrone	Brown cable	Fil brun	Cable marrón	Kabel Brown-Blau (Schließer)	BN
Cavo Blu	Blue cable	Fil bleu	Cable azul		BU
Cavo Giallo/Verde Solo su micro cod. MIC 001/S	Yellow/green cable Only micro cod.MIC001/S	Fil jaune et vert uniquement micro cod. MIC001/S	Cable amarillo/verde Sólo en micro cod. MIC 001 / S	(Kabel Gelb/Grün nur am Mikroschalter mit Kode MIC 001 / S)	GN-YE

Collegamento micro	Contact safety switch	Connexion micro	Conexión micro	Anschluss des Mikroschalters
<p>I microinterruttori di sicurezza delle protezioni devono essere collegati al circuito di emergenza della macchina = PULSANTE DI EMERGENZA. I microinterruttori delle nostre protezioni sono dotati di N° 2 contatti NC e un NO. Se il PULSANTE DI Emergenza è dotato di un solo contatto NC :il contatto NC (fili nero e bianco nero) del microinterruttore deve essere collegato in serie al contatto NC del pulsante . I rimanenti contatti devono essere isolati e lasciati liberi.</p>	<p>The safety switch must be connected to the emergency circuit of the machine = EMERGENCY BUTTON. The switching elements of our guards have: two off NC (Normally Closed) and one off NO (Normally Open). If the EMERGENCY BUTTON has only one NC contact: The NC (black and white - black wire) of the microswitch must be connected in series to the NC contact of the button. The remaining contacts should be isolated and set free.</p>	<p>Les gardes de sécurité microinterrupteurs doivent être connectés au circuit d'urgence de la machine = BOUON D'URGENCE. La commutation de notre gardes sont équipées N°2 NC et contact N°1 NO. Si le BOUON D'URGENCE a un contact NC:le contact NC (fils noir et blanc noir) du micro doit être connecté en série avec le contact NC du bouton. Les contacts restants doivent être isolés et lâché.</p>	<p>El micro de seguridad debe estar conectado al circuito de emergencia de la máquina al igual que el pulsador de emergencia.El micro de nuestra protección está equipado con dos contactos NC y uno NO. Si el pulsador de emergencia está equipado con sólo un contacto NC, el contacto NC (cables negro y blanco negro) del microinterruptor debe estar conectado en serie con el botón de contacto NC. Los contactos restantes se deben aislar y se sueltan.</p>	<p>Der Sicherheitsmikroschalter muss an das Sicherheitskreis der Maschine (NOT-AUS-TASTE) angeschlossen werden. Die Mikroschalter unserer Schutzeinrichtungen sind mit zwei Öffnern (NC) und einem Schließer (NO) ausgestattet. Falls der NOT-AUS-TASTE mit nur einem Öffner vorgesehen ist, muss der Öffner des Mikroschalters (schwarz u. schwarz-weiß Kabel) dem Taste-Öffner in Reihe angeschlossen werden. Alle andere Kontakte müssen getrennt und losgelassen werden.</p>

<p>3.0</p> <p>Se il pulsante d'emergenza è dotato di due contatti NC e un contatto NO, il contatto NC (fili nero e bianco nero) del microinterruttore deve essere collegato in serie ad uno dei contatti NC del pulsante.</p> <p>Il contatto NC (fili rosso e bianco rosso) del microinterruttore deve essere collegato in serie all'altro contatto NC del pulsante.</p> <p>Il contatto NO (fili blu e marrone) del microinterruttore deve essere collegato in parallelo al contatto NO del pulsante.</p> <p>Ove è presente il filo GIALLO/VERDE (microinterruttori con involucro in ferro) deve essere collegato al circuito di terra della macchina.</p>	<p>3.0</p> <p>If the emergency button has two NC contacts and a NO contact, the NC contact (black and white - black wire) of the microswitch must be connected in series to one of the NC contacts of the button.</p> <p>The NC contact (red and white - red wire) of the switch must be connected in series to another NC contact of the button.</p> <p>The NO contact (blue and brown wires) must be connected to the switch in parallel to the NO contact of the button.</p> <p>Where the wire is YELLOW / GREEN (microswitches cased in metal), this must be connected to the earth circuit of the machine.</p>	<p>3.0</p> <p>Si le bouton d'urgence a deux à ouverture et fermeture, le contact NC (fils noir et blanc noir) du micro doit être raccordé en série à l'un des contacts NF du bouton.</p> <p>Le contact NC (fils rouge et blanc rouge) du micro doit être raccordé en série à l'autre contact NF du bouton.</p> <p>Le contact (bleu et fils marron) du micro doit être branché en parallèle avec le contact NO du bouton.</p> <p>Où est le fil JAUNE/VERT (micro avec boîtier fer) doit être raccordé au circuit de terre de la machine.</p>	<p>3.0</p> <p>Si el pulsador de emergencia tiene dos contactos NC y uno NO, el contacto NC (cables negro y blanco negro) del microinterruptor debe estar conectado en serie a uno de los contactos NC del pulsador de emergencia.</p> <p>El otro contacto NC (cables rojo y blanco rojo) del microinterruptor debe estar conectado en serie a la siguiente contacto NC del pulsador de emergencia.</p> <p>El contacto NO (cables azul y marrón) del micro debe conectarse en paralelo con el contacto del pulsador de emergencia.</p> <p>Si está presente el cable AMARILLO/VERDE (microinterruptores con carcasa de hierro), éste debe estar conectado al circuito de tierra de la máquina.</p>	<p>3.0</p> <p>Wenn die NOT-AUS-TASTE zwei Öffner (NC) und einen Schließer (NO) besitzt, muss der Öffner des Mikroschalters (schwarz u. schwarz-weiß Kabel) an einem der Öffner der Taste in Reihe angeschlossen werden. .</p> <p>Der Öffner (NC) des Mikroschalters (rot und weiß-rot Kabel) muss an den nächsten Öffner der NOT-AUS-TASTE in Reihe verbunden werden.</p> <p>Der Schließer (NO) des Mikroschalters (blau und braun Kabel) muss parallel an den Schließer des Knopfes angeschlossen werden.</p> <p>Falls ein Gelber/Grüner Kabel (Mikroschalter mit Eisen-Gehäuse) anwesend ist, muss der an die Erdung der Maschine verbunden werden.</p>
---	--	--	---	--

<p>4.0 Funzionamento ed uso</p>	<p>4.0 Operation and use</p>	<p>4.0 Fonctionnement et emploi</p>	<p>4.0 Funcionamento y utilizacion</p>	<p>4.0 Betrieb und Nutzung</p>
<p>Il riparo è destinato ad essere utilizzato su una macchina utensile, e lo schermo di protezione deve essere idoneo per eventuali proiezioni prevedibili (trucioli, rottura utensile, ecc.- si veda lo spessore della protezione); inoltre non deve essere soggetto a sbalzi di temperatura, a contatto con trucioli incandescenti e fluidi lubrificanti particolarmente acidi (alte concentrazioni).E' vietato utilizzare la protezione per arrestare gli organi mobili pericolosi (riparo senza dispositivo di bloccaggio all'apertura).E' vietato utilizzare la protezione, alla sua chiusura, per avviare gli organi mobili della macchina protetta (il circuito di sicurezza deve prevedere un comando di ripristino e di avviamento separati – a cura del cliente finale). In caso di riparo con sistema di bloccaggio, il cablaggio nel circuito di sblocco del riparo è a cura del cliente finale, e deve essere gestito in sicurezza.</p> <p>E' severamente vietato rimuovere la protezione. Sotto riportato il simbolo che indica il divieto di rimozione applicato sulla protezione.</p>	<p>The guard is designed for use on machine tools and the guard screen must be suitable for all foreseeable projections (swarf, tool breakage etc, see technical data (2.0) for protection thickness). Moreover, it must not be subjected to sudden changes of temperature, contact with red hot swarf or, in particular, acidic lube refrigerant fluid (high concentrations).The guard must not be used to stop dangerous moving parts (guard without opening blockage device).The guard must not be used, on closing, to start the secured machine moving parts (the safety circuit must provide a separate reset and start command by the end user).For a guard with blockage system, the wiring in the guard unlocking circuit is the responsibility of the end user and must be managed safely.</p> <p>It is strictly forbidden to remove the guard. This is indicated by the symbol attached to the screen.</p>	<p>Le protecteur est destiné à être utilisé sur une machine-outil, et l'écran de protection doit être en mesure de protéger, le cas échéant, contre toute projection prévisible (copeaux, rupture d'outil, etc.- voir l'épaisseur de la protection) ; par ailleurs, il ne doit pas être soumis à des variations de température et ne doit pas entrer en contact avec des copeaux incandescents ou des fluides lubrifiantes particulièrement acides (concentrations élevées). Il est interdit d'utiliser la protection pour arrêter les organes mobiles dangereux (protecteur dépourvu du dispositif de blocage à l'ouverture).Il est interdit d'utiliser la protection, lors de sa fermeture, pour faire démarrer les organes mobiles de la machine protégée (le circuit de sécurité doit prévoir une commande de réarmement et une commande de démarrage séparées – à la charge du client final). En cas de protecteur avec système de blocage, le câblage dans le circuit de déblocage du protecteur doit être exécuté par le client final et doit être géré en toute sécurité.</p> <p>Il est strictement interdit d'enlever la protection. Le symbole indiquant l'interdiction appliquée à la suppression de la protection.</p>	<p>La protección está destinada a utilizarse en una máquina herramienta similar, y la pantalla de protección debe ser adecuada para las posibles proyecciones (virutas, ruptura de la herramienta, etc. consultar el grosor de la protección); asimismo, no debe someterse a cambios bruscos de temperatura por contacto con virutas incandescentes y líquidos refrigerantes y lubricantes especialmente ácidos (concentraciones elevadas). Está prohibido utilizar la protección para detener los órganos móviles peligrosos (resguardo sin dispositivo de enclavamiento en la apertura). Está prohibido utilizar la protección, para que a su cierre, se produzca el arranque de los órganos móviles de la máquina protegida (el circuito de seguridad debe prever un rearme y arranque separados – a cargo del cliente final). En caso de resguardo con sistema de bloqueo el cableado del circuito de desbloqueo del resguardo correrá a cargo del cliente final y deberá realizarse con total seguridad.</p> <p>Está estrictamente prohibido quitar la protección. Este símbolo indica la prohibición expresa de la retirada de la protección.</p>	<p>Die Schutzeinrichtung ist auf Werkzeugmaschinen zu verwenden. Der Schirm dient dazu, der Maschinenbediener von herumfliegenden Materialien (Spänen, gebrochene Teilen, usw. - Siehe Dicke des Polykarbonat) zu schützen und sollte keine Temperaturschwankungen erleiden oder mit heißen Spänen, sauren Kühlschmierstoffen (hohe Konzentration) nicht in Kontakt kommen Sie muss nicht verwendet werden, um gefährliche bewegliche Teile zu stoppen (die Vorrichtung ohne Verriegelung öffnen). Es ist ebenso verboten, die Vorrichtung beim Schließen zu benutzen, um die bewegliche Teile der Maschine zu starten (der Endverbraucher/Monteur soll separate Rückstellen- und Wiederanlauf-Befehle im Sicherheitskreis vorsehen). Im Fall von mit Verriegelungssystem ausgestatteten Schutzeinrichtungen muss der Endverbraucher die Verkabelung im Lösen-Kreis in ganze Sicherheit ergänzen.</p> <p>Es ist strengstens verboten, die Sicherheitsvorrichtung außer Kraft zu setzen. Hier unten finden Sie das auf der Vorrichtung angelegte Verbot-Piktogramm.</p>



5.0 Certificazione 	5.0 Certification 	5.0 Certification 	5.0 Certification 	5.0 Zertifizierung 
DICHIARAZIONE CE DI CONFORMITA' FORNITA CON LA PROTEZIONE Con riferimento alle seguenti norme armonizzate: EN ISO 12100:2010 EN ISO 14120:2015 EN ISO 14119:2013 EN 60947-5-1:2017	CE DECLARATION OF CONFORMITY SUPPLIED WITH GUARD with regard to the following harmonised standards: EN ISO 12100:2010 EN ISO 14120:2015 EN ISO 14119:2013 EN 60947-5-1:2017	DÉCLARATION CE DE CONFORMITÉ-Fourni avec la PROTECTION En ce qui concerne les normes harmonisées suivantes : EN ISO 12100:2010 EN ISO 14120:2015 EN ISO 14119:2013 EN 60947-5-1:2017	DECLARACIÓN CE DE CONFORMIDAD SUMINISTRADA CON LA PROTECCION Con referencia a las siguientes normas armonizadas: EN ISO 12100:2010 EN ISO 14120:2015 EN ISO 14119:2013 EN 60947-5-1:2017	EG Konformitätserklärung mit der Vorrichtung geliefert Bezug nehmend auf die folgenden harmonisierten Normen: EN ISO 12100:2010 EN ISO 14120:2015 EN ISO 14119:2013 EN 60947-5-1:2017

6.0 Identificazione	6.0 Identification	6.0 Identification	6.0 Identificacion	6.0 Identifizierung
------------------------	-----------------------	-----------------------	-----------------------	------------------------

Targhetta identificativa	Identification plate	Plaque de identification	Placa del fabricante	Typenschild
--------------------------	----------------------	--------------------------	----------------------	-------------



6.1 Controllo qualità	6.1 Quality control	6.1 Le controle di qualite	6.1 Control de calidad	6.1 Qualitätskontrolle
--------------------------	------------------------	-------------------------------	---------------------------	---------------------------

STRUTTURA	STRUCTURE	STRUCTURE	ESTRUCTURA	AUFBAU	
SCHERMO	SCREEN	ÉCRAN	PANTALLA	SCHIRM	
SUPPORTO	SUPPORT	SOUTIEN	SOPORTE	HALTERUNG	
TUBO DI SOSTEGNO	SUPPORT TUBE	SUPPORT DE TUBE	TUBO DE SOPORTE	SUPPORT TUBE	
VITERIA	SCREWS	VIS	TORNILLOS	SCHRAUBEN	

7.0 Manutenzione	7.0 Maintenance	7.0 Entretien	7.0 Mantenimiento	7.0 Wartung
Operazione di pulizia: Acqua e Sapone	Clean with water and soap.	Nettoyage: L'eau et du Savon	Limpieza: Agua y Jabón	Reinigung: Wasser und Seife
Controllo del corretto funzionamento del dispositivo di interblocco Apertura e chiusura	Check the correct operation of the interlock device, both opening and closing.	Vérifiez le bon fonctionnement du dispositif de verrouillage Ouverture et fermeture	Compruebe periodicament el correcto funcionamiento del micro de seguridad . Apertura y cierre	Überprüfung der korrekten Funktionsweise des Sicherheitsmikroschalters: die Schutzeinrichtung öffnen und schließen
Verifica delle integrità e del serraggio dei grani di fissaggio	Verify the integrity and tightness of all fixing screws.	La vérification de l'intégrité et de serrer les vis de fixation	Compruebe periodicament el correcto funcionamiento	Überprüfen dass die Gewindestifte, die das Schutzschirm am Tragarm befestigen nicht beschädigt oder locker sind.
In caso di riparazione apporre: Macchina non in sicurezza	In case of malfunction, isolate the machine following lock-out / tag-out procedure.	En cas d'apposer de réparation: La machine n'est pas sécuritaire	En caso de reparación pendiente: La máquina no es segura	Im Fall von Reparaturen: das Schild „Maschine nicht sicher“ anbringen

8.0 Condizioni di stoccaggio	8.0 Storage conditions	8.0 Condition de stockage	8.0 Condiciones de almacenamiento	8.0 Lagerbedingungen
Lasciare la protezione nel sacchetto protettivo	Store guard in protective bag until required.	Laisser protection dans un sac de protection	Deja la protección en la bolsa protectora del embalaje original	Lassen Sie Schutz in Schutztasche

8.1 Smaltimento	8.1 Disposal	8.1 Élimination	8.1 Disposición	8.1 Entsorgung
<p>Prima di effettuare operazioni di smaltimento dei componenti che costituiscono il prodotto, consultare il fabbricante, che indicherà le modalità operative nel rispetto dei principi di sicurezza e di salvaguardia ambientale. Il prodotto può essere smaltito senza bisogno di ridurlo in pezzi minuti; è sufficiente scollegare i principali gruppi che la compongono e porli sul mezzo di trasporto adibito alla rottamazione. Provvedere al loro smaltimento operando in conformità alle norme vigenti, rivolgendosi agli organismi preposti e/o ad imprese specializzate nella rottamazione e/o nello smaltimento dei rifiuti, affinché avvenga la separazione tra materiale plastico, materiale metallico e componenti che devono essere inviati a raccolte differenziate. È obbligo del datore di lavoro essere a conoscenza delle leggi vigenti in merito nel proprio paese e operare in modo da ottemperare a tali legislazioni. È vietato ed inoltre passibile di sanzioni, abbandonare il prodotto nell'ambiente</p>	<p>Before you dispose of the components that make up the product, contact the manufacturer, who will be able to advise you regarding methods that comply with local environmental regulations. The product can be disposed of without being broken into small parts. Simply disassemble the main groups and bring them to waste collection. Dispose of them in compliance with current regulations, using agencies and/or firms specializing in scrapping and/or waste disposal, so that plastic material, metallic material and components that must be sent to the waste collection are separated. It is the responsibility of the employer to be aware of the laws in force in the country and comply with such legislation. It is also prohibited and punishable by law to leave the product in the environment.</p>	<p>Avant d'effectuer l'élimination des éléments qui composent le produit, contactez le fabricant, qui indiquera les modes de fonctionnement en conformité avec les principes de sécurité et de protection de l'environnement. Le produit peut être éliminé sans avoir besoin de le casser en petits morceaux: il suffit de débrancher les principaux groupes qui le composent et de les amener aux moyens de transport utilisés pour la destruction. Éliminer les faire fonctionner en conformité avec la réglementation en vigueur, s'adressant aux agences et / ou des entreprises spécialisées dans la mise au rebut et / ou de l'élimination des déchets, ainsi que la séparation entre la matière plastique, matériau métallique et des composants qui doivent être transmis à la collecte des déchets . Il appartient à l'employeur de connaître les lois en vigueur dans leur pays et sur le travail afin de se conformer à ces lois. Il est également interdit et passible de sanctions, laissez le produit dans l'environnement</p>	<p>Antes de llevar a cabo la eliminación de los componentes que conforman el producto, póngase en contacto con el fabricante, que le indicará los métodos de funcionamiento de conformidad con los principios de seguridad y protección del medio ambiente. El producto puede ser eliminado sin necesidad de dividirlo en partes más pequeñas: simplemente desconecte los principales grupos que la componen y lívelos a los medios de transporte utilizados para la destrucción. Deshágase de ellos en cumplimiento de la normativa vigente, dirigiéndose a los organismos y / o empresas especializadas en el desguace y / o eliminación de residuos, de forma que la separación entre el material plástico, material metálico y los componentes que debe enviarse a la recogida de residuos . Corresponde al empresario estar al tanto de las leyes vigentes en su país y sobre el trabajo con el fin de cumplir con dicha legislación. Le recordamos también que está prohibido y castigado penalmente, arrojar el producto al medio ambiente.</p>	<p>Bevor die Bauelemente der Schutzeinrichtung entsorgt werden, sollte man deren Hersteller befragen, um gemäß der Sicherheits- und Umweltschutznormen zu vorgehen. Es ist nicht nötig die Einrichtung abzubrechen. Man braucht nur die wichtigsten Baugruppen abzutrennen und sie auf einem LKW oder einem anderen Mittel zur Verschrottung zu laden. Die Entsorgung soll gemäß der geltenden Normen durch in Verschrottung und Entsorgung spezialisierte Firmen erfolgen, die in der Lage sind, Kunststoff, Metalle oder andere Materialien gut zu sammeln und zu trennen. Dem Arbeitgeber müssen die Richtlinien in Kraft in eigenem Land bewusst sein und er muss gemäß diese Rechtsvorschriften handeln. Es ist auch verboten und mit Strafen bedroht, das Produkt in die Umwelt abzugeben.</p>

9.0 Esploso	9.0 Exploded View	9.0 Schema	9.0 Plano de despiece	9.0 Explosionszeichnung
----------------	----------------------	---------------	--------------------------	----------------------------

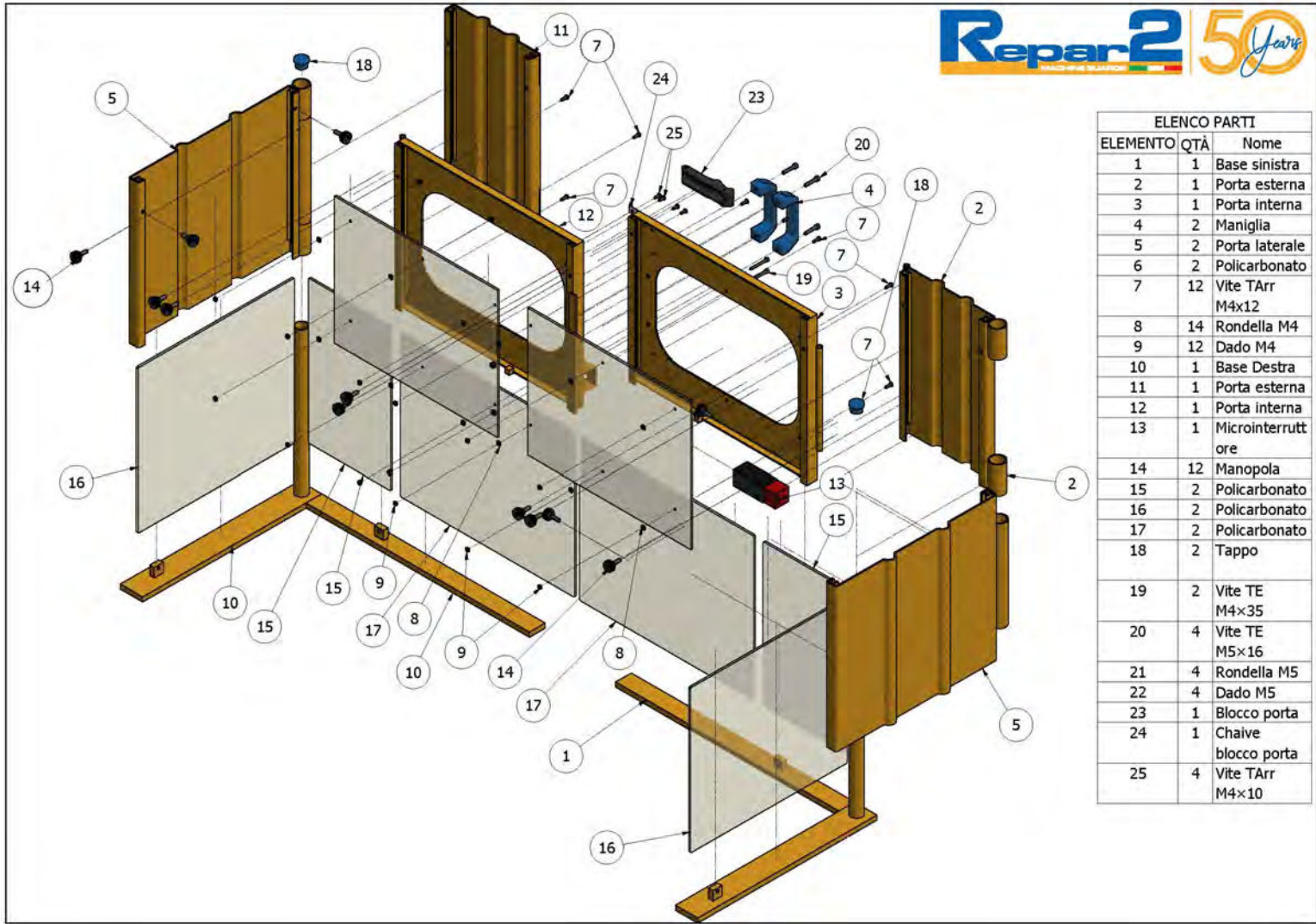

ELENCO PARTI		
ELEMENTO	QTÀ	Nome
1	1	Base sinistra
2	1	Porta esterna
3	1	Porta interna
4	2	Maniglia
5	2	Porta laterale
6	2	Polycarbonato
7	12	Vite TArr M4x12
8	14	Rondella M4
9	12	Dado M4
10	1	Base Destra
11	1	Porta esterna
12	1	Porta interna
13	1	Microinterruttore
14	12	Manopola
15	2	Polycarbonato
16	2	Polycarbonato
17	2	Polycarbonato
18	2	Tappo
19	2	Vite TE M4x35
20	4	Vite TE M5x16
21	4	Rondella M5
22	4	Dado M5
23	1	Blocco porta
24	1	Chaive blocco porta
25	4	Vite TArr M4x10

10.0 Esempio di montaggio	10.0 Example of assembly	10.0 Exemple de montage	10.0 Ejemplo de montaje	10.0 Montage Beispiel
------------------------------	-----------------------------	----------------------------	----------------------------	--------------------------



Repar2

MACHINE GUARDS 

di **Carnovali Marco Ottavio** Via Ambrogio Colombo, 176- 21055 Gorla Minore (VA) – Italy
 www.repar2.com -info@repar2.com Tel:+39 0331 465727 Fax:+39 0331 465728
 Export Dept: exportoffice@repar2.com

UCIMU-SISTEMI PER PRODURRE
 MEMBER COMPANY

Distributore	Distributor	Distributeur	Distribuidor	Händler
--------------	-------------	--------------	--------------	---------



MANUALE DELLE ISTRUZIONI PER L'USO	MANUAL OF INSTRUCTIONS FOR USE	MANUEL D'INSTRUCTIONS POUR L'UTILISATION	MANUAL DE INSTRUCCIONES DE USO	BEDIENUNGSANLEITUNG
<p>N. volumi: 1 Data: Revisione: 00 ©Copyright 2013 – REPAR2 Senza la preventiva autorizzazione scritta della REPAR2 questo manuale o parte di esso non può essere riprodotto in nessuna forma, modificato, trascritto, tradotto in qualsiasi lingua, reso disponibile a terzi o comunque usato in modo che possa pregiudicare gli interessi della REPAR2. Ogni abuso sarà perseguito ai sensi di legge e sui diritti d'autore.</p>	<p>N. volumes: 1 Date: Revision: 00 © Copyright 2013 - REPAR2 Without the prior written permission of REPAR2, this manual or any part of it may not be reproduced in any form, edited, transcribed, translated into any language, made available to third parties or used in a manner that is likely to affect the interests of REPAR2. Any violation will be prosecuted according to law and copyright.</p>	<p>N. volumes: 1 Date: Révision: 00 © Copyright 2013 - REPAR2 Sans l'autorisation écrite préalable de REPAR2 ce manuel ou toute partie de celle-ci ne peut être reproduit sous quelque forme que modifié, transcrit, traduit dans une autre langue, mis à la disposition des tiers ou utilisées d'une manière qui est susceptible d'affecter les intérêts de la REPAR2 Toute infraction sera poursuivie conformément à la loi et le droit d'auteur.</p>	<p>N. volúmenes: 1 Fecha: Revisión: 00 © Copyright 2013 - REPAR2 Sin la previa autorización por escrito de REPAR2 este manual o cualquier parte del mismo no puede ser reproducido en cualquier forma, editar, transcribir, traducir a ningún idioma, poner a disposición de terceros ni utilizados de manera que pueda afectar a los intereses de REPAR2 Cualquier violación de éstas normas será perseguida de acuerdo con la ley y los derechos de autor.</p>	<p>Nr. Volumen: 1 Datum: Revision: 00 © Copyright 2013 - REPAR2 Es ist strengstens verboten, diese Anleitung oder Teile davon ohne schriftliche Genehmigung von REPAR2 in keiner Form zu vervielfältigen, ändern, transkribieren, in irgendeiner Sprache übersetzen oder zur Verfügung von Dritten zu stellen oder sie auf eine Weise zu benutzen, dass die Interessen der REPAR2 beeinträchtigt werden. Jeder Verstoß wird nach dem Gesetz und Urheberrecht verfolgt werden.</p>